

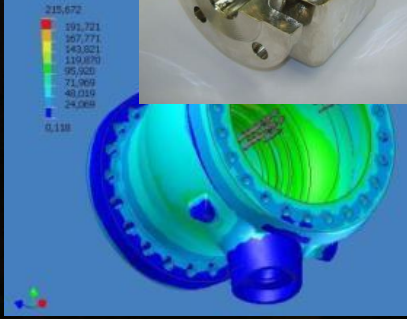

Válvulas Industriales. FEVISA



TALLERES
JESUS ALVAREZ, S.A.



FIN

FEVISA FACTORY IN SPAIN



Corporate Summary - FEVISA

- Manufacturing industrial valves since 1968
- State of the art manufacturing facility at Valnalon, Spain admeasuring 800,000 square feet
- FEVISA valves enjoy API certification
- Good product range
- Established a modern warehouse at Dubai South, UAE
- Warehouse stocks inventory of several million dollars
- Middle East & Asia client list includes Dugas, NPCC, DEWA, GASCO, ENOC, Tatweer, Petronas, Essar, Saudi Aramco, Qatar Petroluem, Technip etc.

TALLERES JESUS ALVAREZ, S.A.

VALVULAS INDUSTRIALES FEVISA

- **Industry:** Type of customers

- ▶ Oil&Gas upstream, downstream and process industry.



- ▶ Mining industry.



TALLERES JESUS ALVAREZ, S.A.

VALVULAS INDUSTRIALES FEVISA

- **Design & Production:** Prototypes design

Calculations and 2D & 3D CAD design

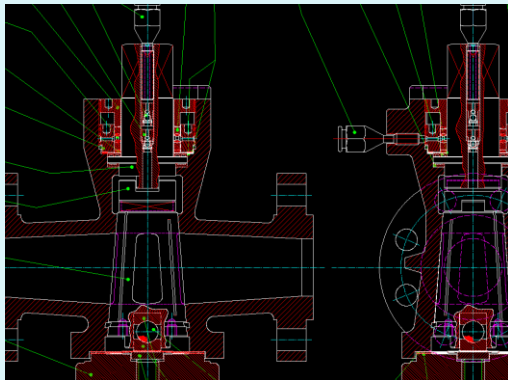
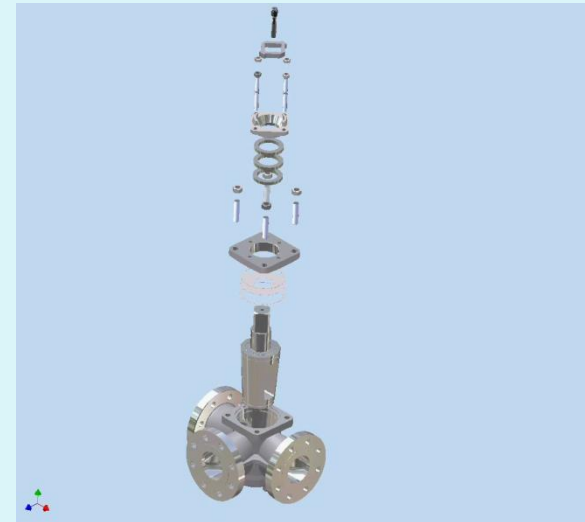
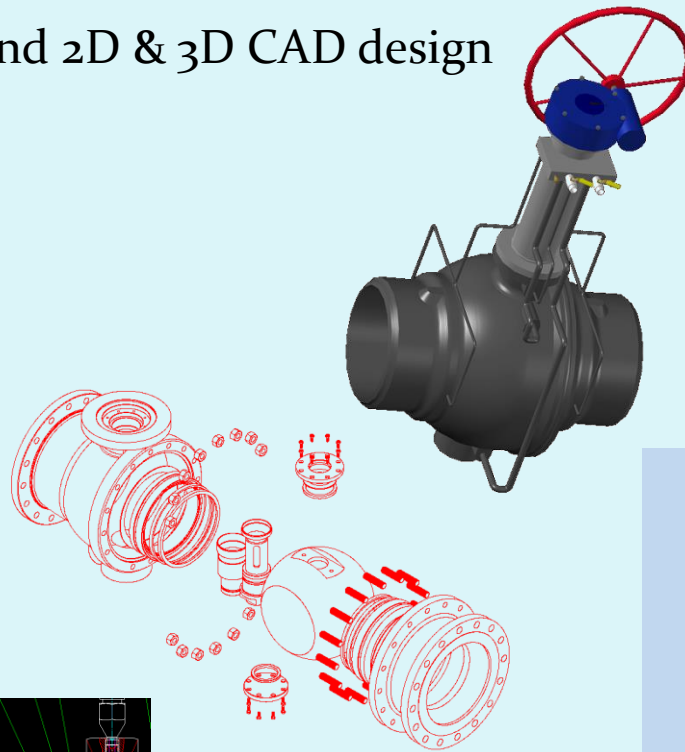
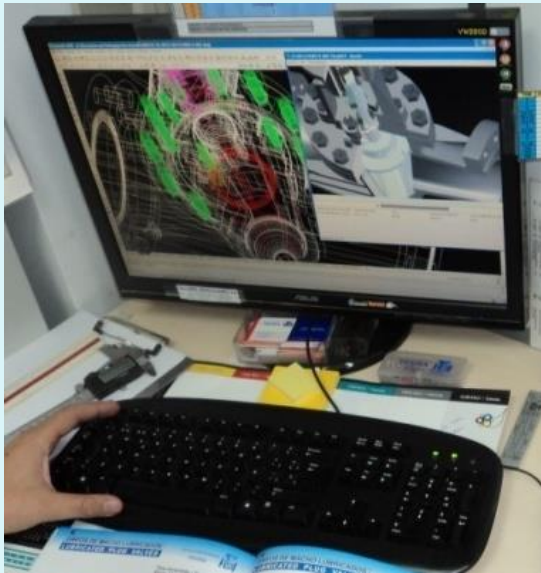

TALLERES JESUS ALVAREZ, S.A.

VALVULAS INDUSTRIALES FEVISA

- **Design & Production:** Prototypes design
Finite element analysis, strain test & fire test

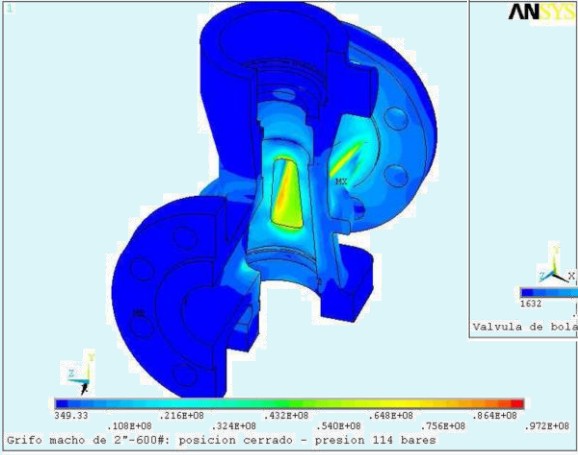
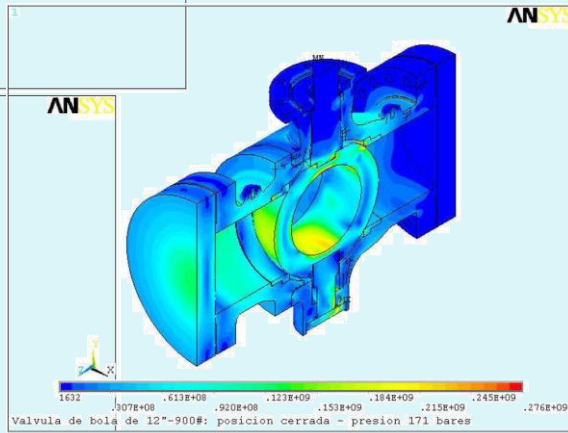
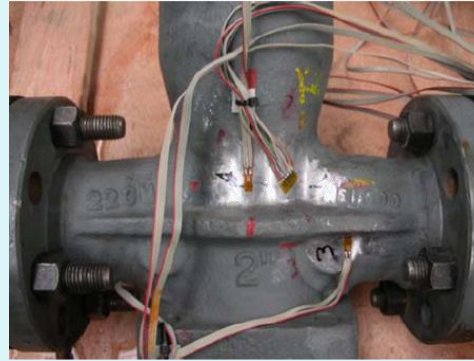
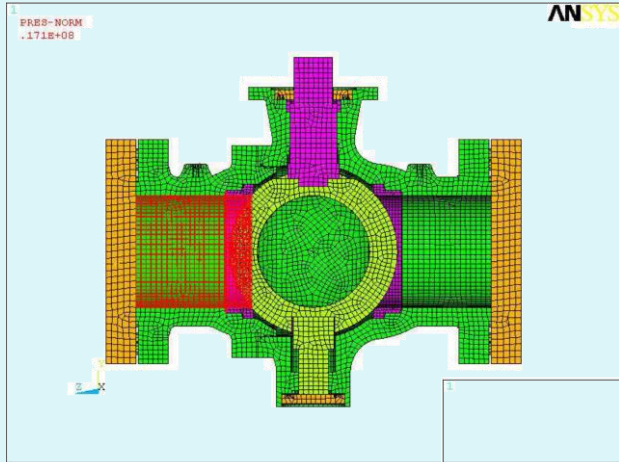

TALLERES JESUS ALVAREZ, S.A.

VALVULAS INDUSTRIALES FEVISA

- **Design & Production: Manufacturing**



Wooden model



Machining



Packing



Casted steel



Assembling



Marking

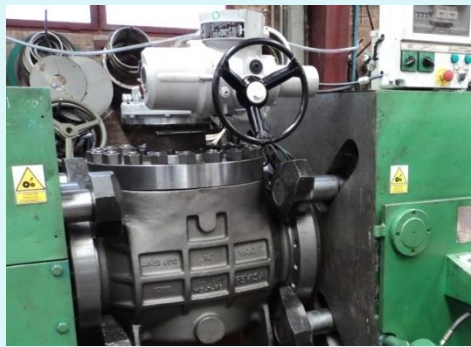

Testing

TALLERES JESUS ALVAREZ, S.A.

VALVULAS INDUSTRIALES FEVISA

- **Design & Production: Product range**



Ball valves

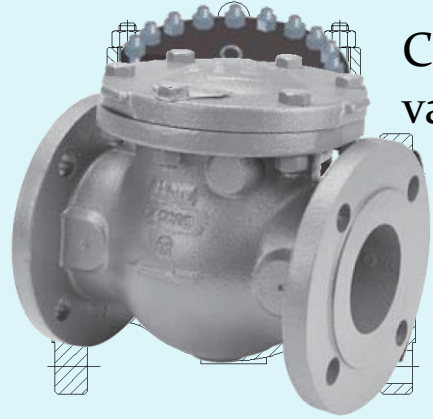

Check valves

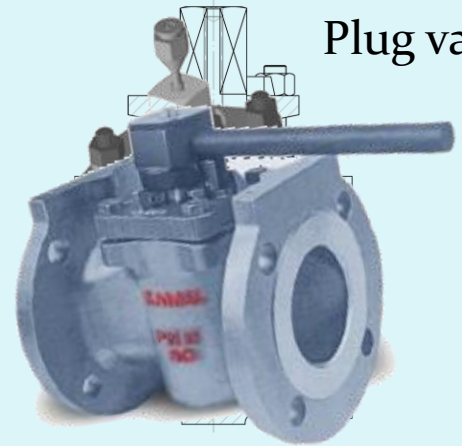

Plug valves



Gate valves

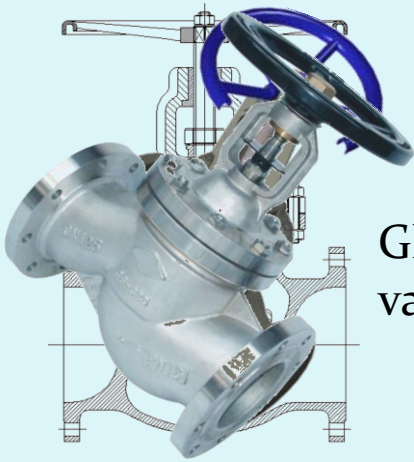

Globe valves

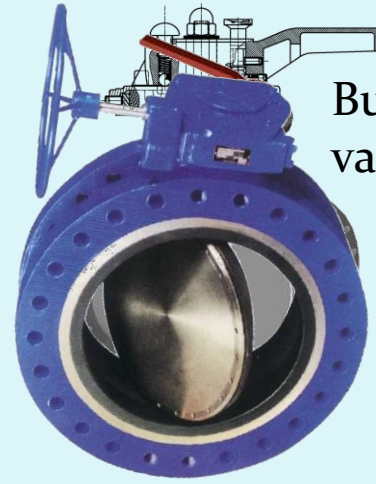

Butterfly valves

TALLERES JESUS ALVAREZ, S.A.

VALVULAS INDUSTRIALES FEVISA

- **Highlighted projects:** Heavy duty valves



TALLERES JESUS ALVAREZ, S.A.

VALVULAS INDUSTRIALES FEVISA

- **Highlighted projects: Big size valves**



TALLERES JESUS ALVAREZ, S.A.

VALVULAS INDUSTRIALES FEVISA

- Highlighted projects: Large projects



TALLERES JESUS ALVAREZ, S.A.

VALVULAS INDUSTRIALES FEVISA

- **Highlighted projects: Underground valves**



TALLERES JESUS ALVAREZ, S.A.

VALVULAS INDUSTRIALES FEVISA

- **Highlighted projects:** Ad hoc projects
10 meters extended stem for IBERDROLA

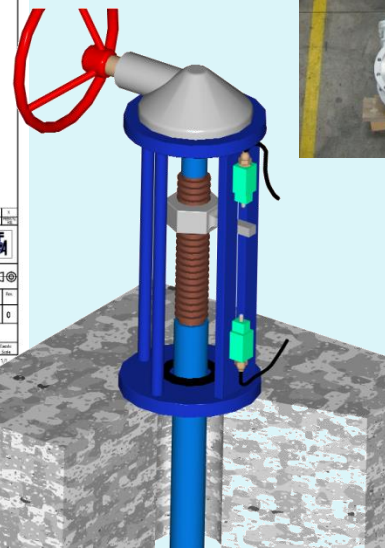
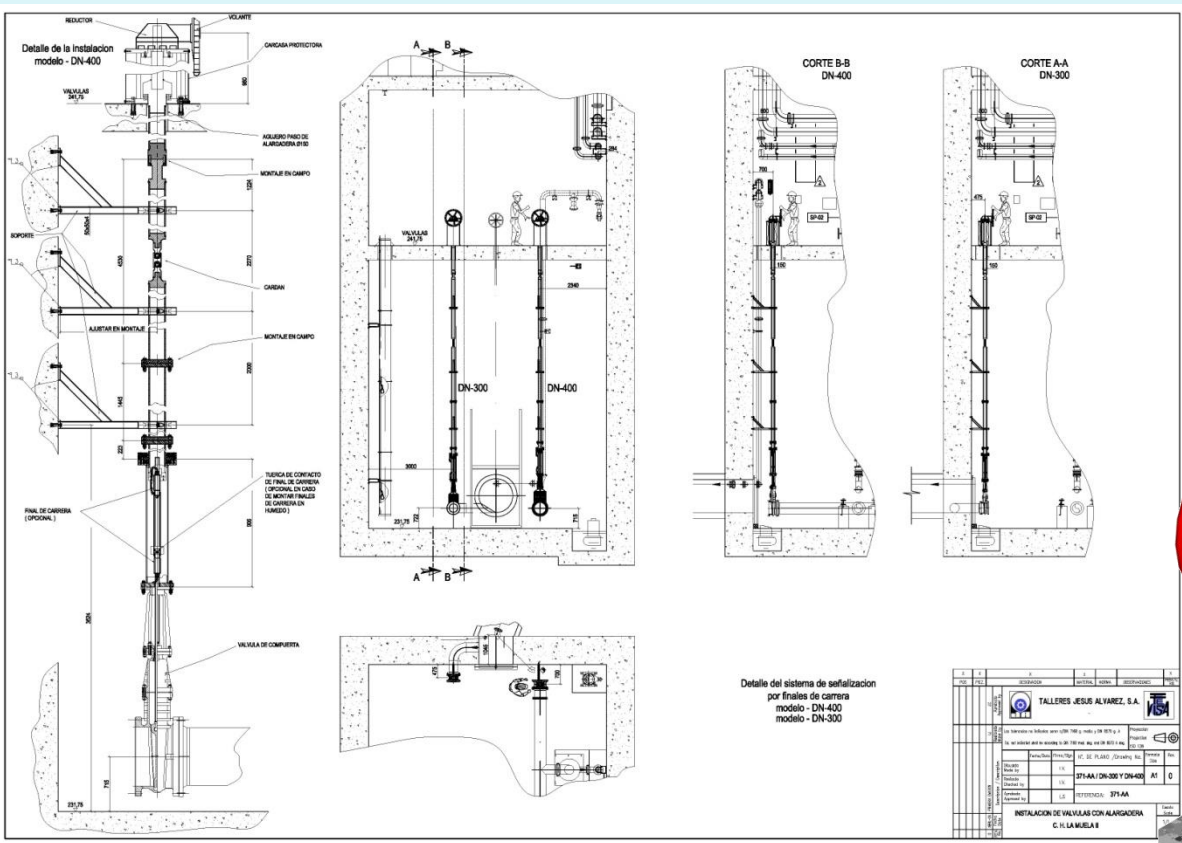

TALLERES JESUS ALVAREZ, S.A.

VALVULAS INDUSTRIALES FEVISA

- **Business: Markets – Spain**



TALLERES JESUS ALVAREZ, S.A.

VALVULAS INDUSTRIALES FEVISA

- Business: Markets – Egypt

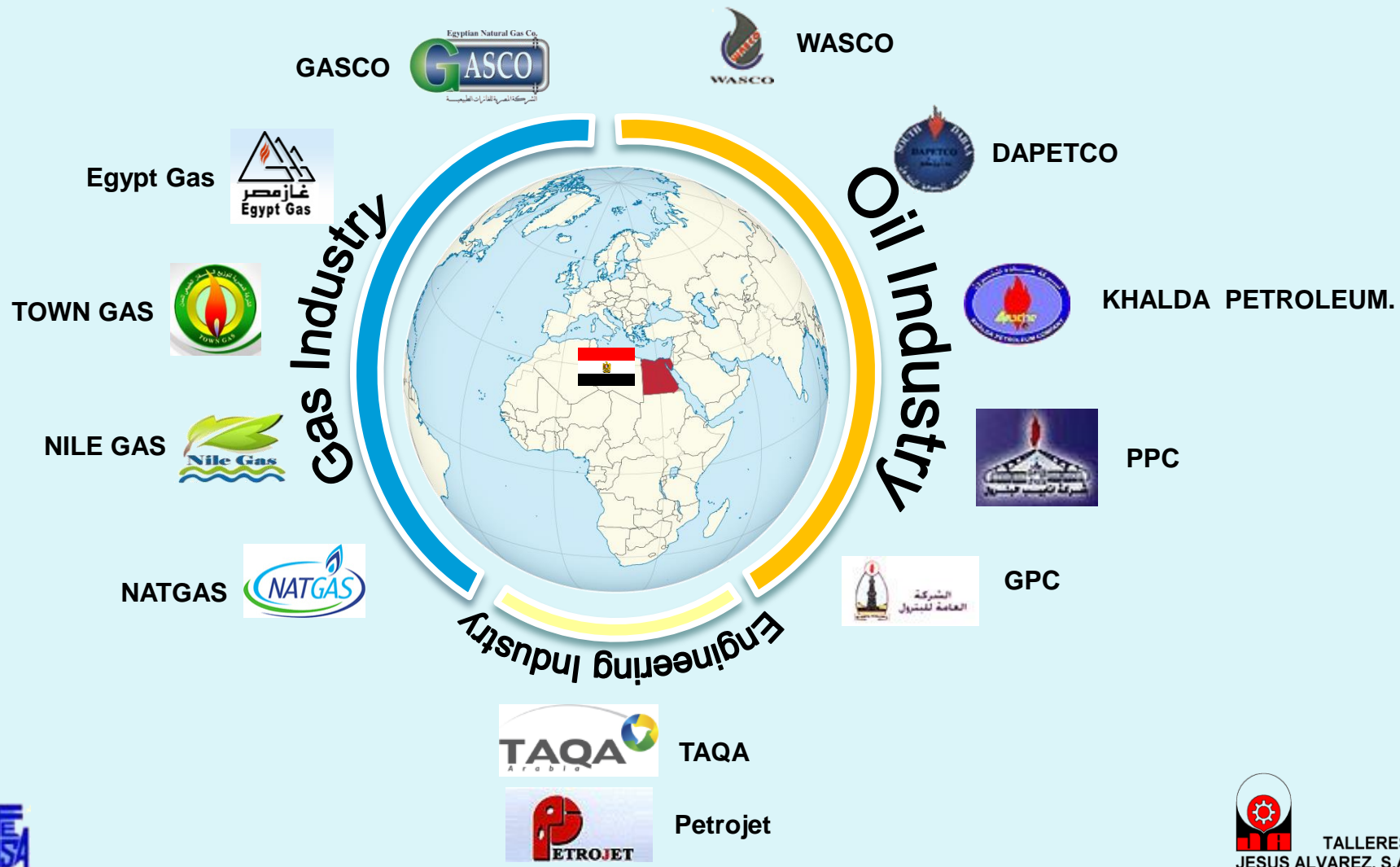

TALLERES JESUS ALVAREZ, S.A.

VALVULAS INDUSTRIALES FEVISA

- **Business: Markets – America**



TALLERES JESUS ALVAREZ, S.A.

VALVULAS INDUSTRIALES FEVISA

- **Business: Markets – Asia (Valtronics)**

The central image is a globe with the Asian continent highlighted in red. Surrounding the globe are logos and names of major oil and gas companies from various regions:

- KUWAIT OIL COMPANY** (Kuwait)
- DNO** (Iraq)
- ABU DHABI Technip** (Abu Dhabi)
- QATAR Qatar Petroleum** (Qatar)
- ABU DHABI GASCO** (Abu Dhabi)
- SAUDI ARAMCO – ARABIA SAUDI** (Saudi Arabia)
- EMIRATOS ÁRABES UNIDOS EMIRATES GAS** (UAE)
- TOTAL** (Yemen)
- PETRONAS** (Malaysia)
- ESSAR** (India)
- Cairn** (Australia)

Why FEVISA ?

- Good product range in standard industrial valves- $\frac{1}{4}$ " to 60"
- Strong engineering and machining capabilities.
- Large stocking capacity – enables short deliveries – meets emergency project needs
- Uncomplicated quotation process – quick response
- Well established manufacturing since 1968, experienced technical staff
- API 6D Certification of the factory / ISO 9001 Certification
- Aggressive pricing
- Scalability – from low cost (castings from China/India) to premium range (casting from Spain)
- Flexibility – to meet customer requirements.



Válvulas Industriales. FEVISA